

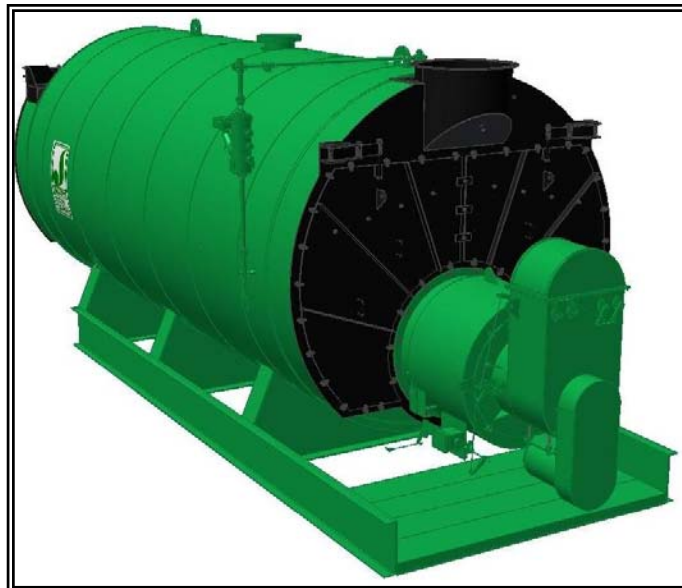

# MODEL: PFTA 1000-4

## 4-Pass Steam Packaged Firetube Boiler



### Ratings & Performance Data

Horsepower 1000							
Steam Storage, ft <sup>3</sup>	198.8	Natural Gas Flow, SCFH (1,000 Btu/ft <sup>3</sup> )**		40,104			
Steam Disengaging Area, ft <sup>2</sup>	161.3	Combustion Air (15% Excess), SCFM***		7,338			
Total Heating Surface, ft <sup>2</sup>	5,081	Flue Gas Flow Rate, lb/hr***		34,973			
Furnace Outside Diameter, in	52.0	Stack Flue Gas Velocity, ft/min***		2,213			
Furnace Heat Release Rate, Btu/ft <sup>3</sup> hr**	152,000	#2 Oil Flow, gal/hr (140,000 BTU/gal)**		275.9			
Total Combustion Volume, ft <sup>3</sup>	343.2	#6 Oil Flow, gal/hr (150,000 BTU/gal)**		255.2			
Total Heat Release Rate, Btu/ft <sup>3</sup> hr**	117,000	Flue Gas Side Pressure Drop, in. H <sub>2</sub> O		9.7			
Water Content N.W.L., gal	5,543	Water Content Flooded, gal.		7,031			
Approx. Dry Weight 15#, lb	65,400	Approx. Operating Weight 15#, lb.		111,900			
Approx. Dry Weight 150#, lb	70,100	Approx. Operating Weight 150#, lb.		116,600			
Approx. Dry Weight 200#, lb	79,000	Approx. Operating Weight 200#, lb.		125,500			
Approx. Dry Weight 250#, lb	89,600	Approx. Operating Weight 250#, lb.		136,100			
Approx. Dry Weight 300#, lb	99,200	Approx. Operating Weight 300#, lb.		145,700			
Performance Data							
Operating Pressure (psig)	Steam Rate (lb/hr)	Natural Gas		#2 Oil		#6 Oil	
		Stack Temp (F)	%Eff	Stack Temp (F)	%Eff	Stack Temp (F)	%Eff
10	34,728	260	85.9	266	89.1	271	89.9
50	34,055	318	84.5	324	87.7	329	88.5
100	33,691	358	83.5	364	86.7	369	87.5
150	33,487	386	82.8	392	86.0	397	86.8
200	33,361	408	82.2	414	85.4	420	86.2
250	33,280	426	81.8	432	85.0	438	85.7
300	33,228	442	81.4	448	84.6	454	85.3
*Based on 228°F feedwater and 3% O <sub>2</sub> , ** Values calculated at 100 psi operating pressure, ***Calculated Firing Natural Gas							

## Drawings - 4-Pass Steam Packaged Firetube Boiler

Connection & Opening Schedule			
Conn.	Description	Type	Qty
FW	Feedwater Inlet	2.00 FNPT	2
MS*	Main Steam	10.00 300# RF	1
CB	Continuous Blowoff	1.00 FNPT	1
BD	Blowdown Outlet	2.00 FNPT	2
MW	Manway	12 X 16	1
HH	Hand Hole	4 X 6	7
*14.00 150#RF Flange on 15 psig Design			

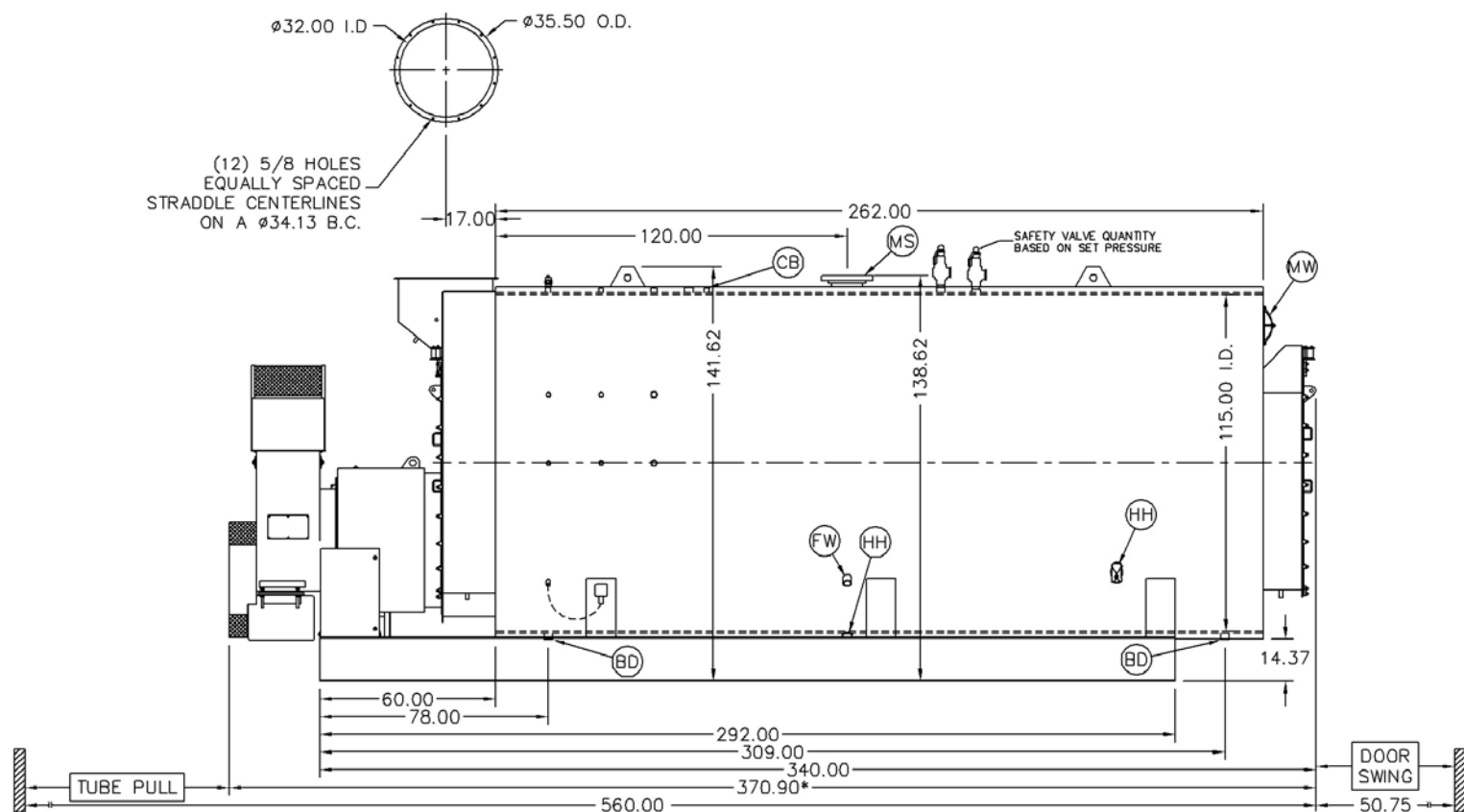
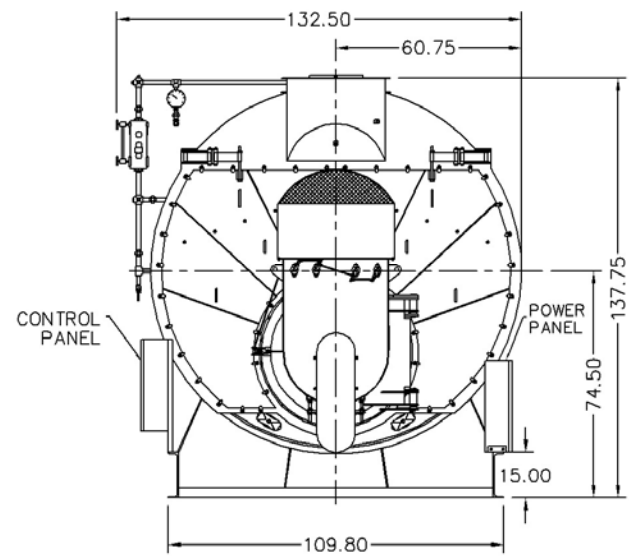

### Notes:

150# Steam design shown, all dimensions given in inches.

Fuel piping and/or optional boiler trim may increase overall width.

Specifications subject to change to incorporate engineering advances.

\*May vary on low-NO<sub>x</sub> designs

# MODEL: PFTA 1000-4

## Base Diagram

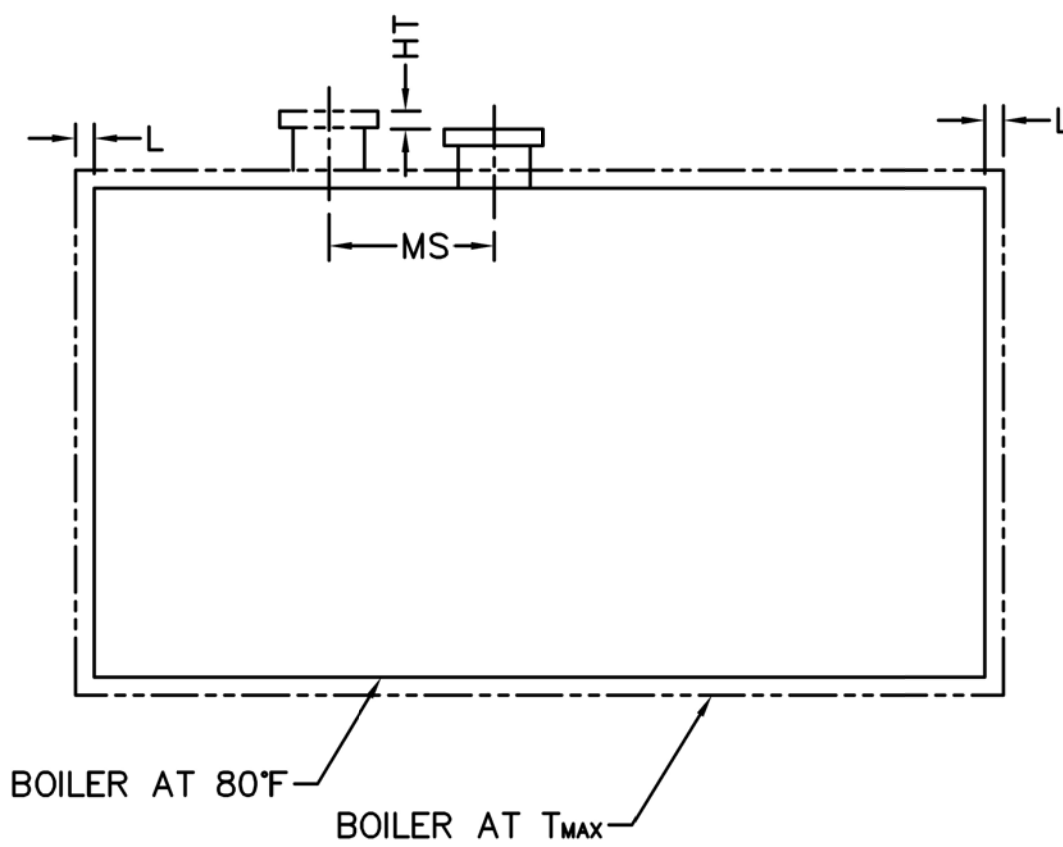
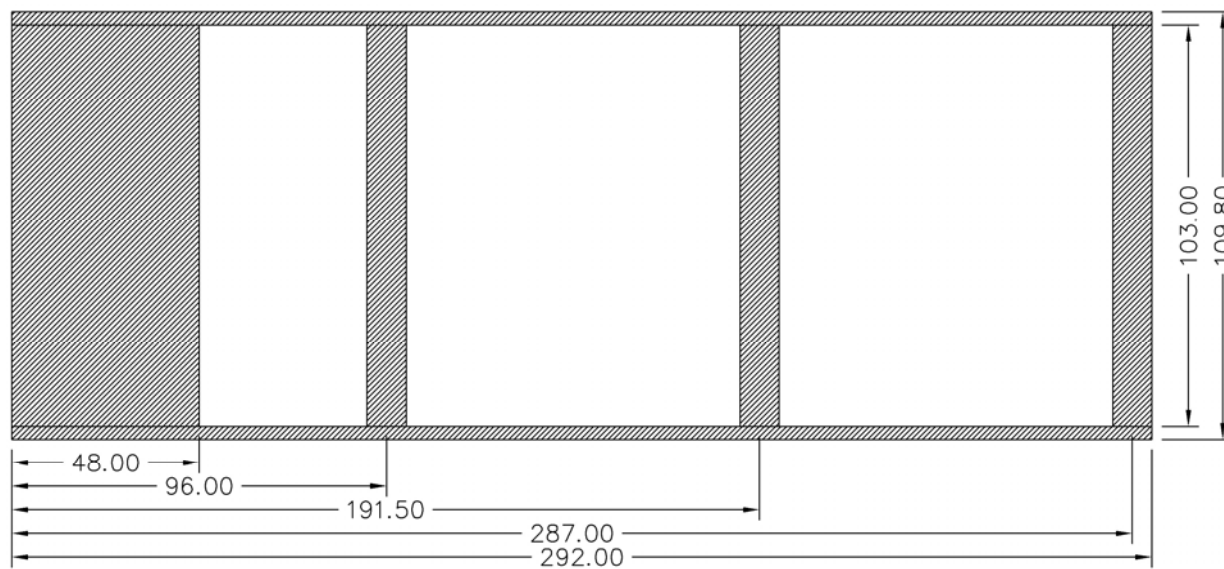

Thermal Expansion					
psig	15	150	200	250	300
Metal T <sub>MAX</sub> (F)	240	366	388	406	421
L (in)	0.133	0.225	0.242	0.256	0.269
MS (in)	0.011	0.019	0.020	0.022	0.023
HT (in)	0.118	0.198	0.214	0.227	0.238

# MODEL: PFTA 1000-4

## Nozzle Loadings

Maximum Allowable Load on Boiler Steam Nozzle					
	15# Design	150# Design	200# Design	250# Design	300# Design
$F_{RRF}$ , lb	7,755	5,320	7,580	9,620	10,375
$M_{RCM}$ , in-lb	60,030	77,500	113,605	158,920	194,790
$M_{RLM}$ , in-lb	94,985	64,800	95,705	121,485	186,135

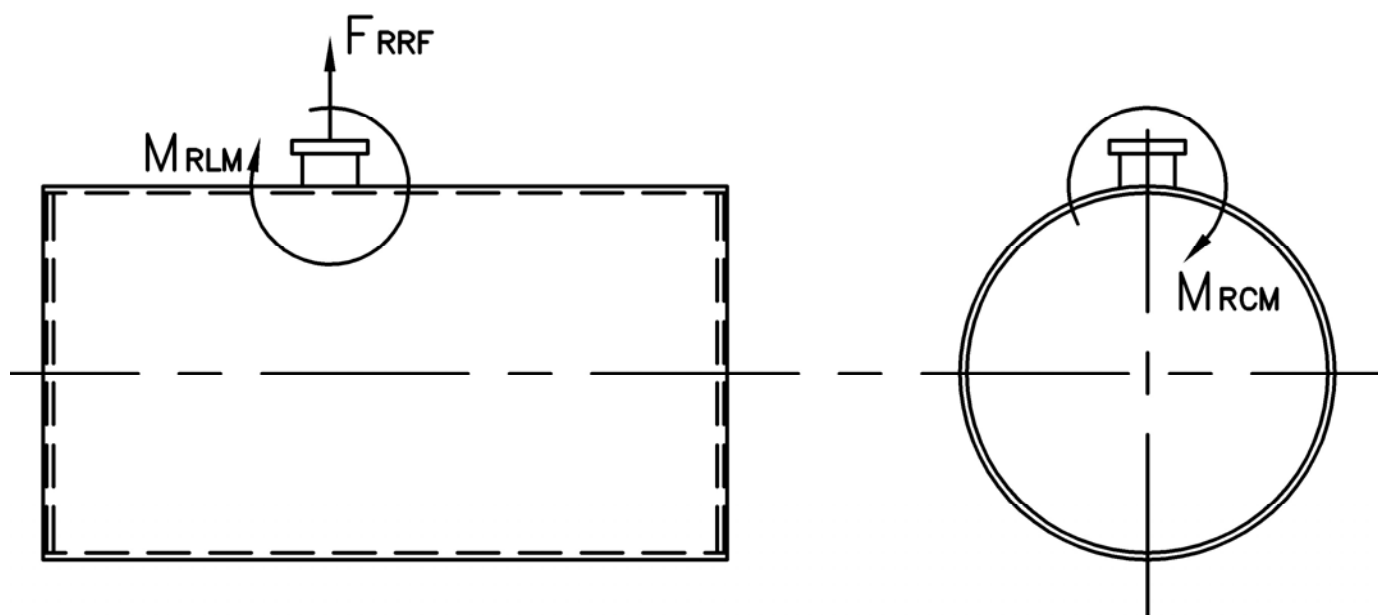

Distributed By:



300 Pine Street  
P.O. Box 300  
Ferrysburg, MI 49409-0300  
Telephone: (616) 842-5050  
Net: www.johnstonboiler.com

Stack Emissions-Natural Gas (1,000 Btu/CF)				
	PPMv (Corr to 3% O <sub>2</sub> )	lb/MBtu	lb/hr @ Full Rate	Ton/Yr @ Full Rate
NO <sub>x</sub> *	110	0.131	5.252	23.003
	30	0.036	1.432	6.273
	9	0.011	0.430	1.882
CO	50	0.037	1.47	6.453
CO <sub>2</sub>	2.55 lb/lb fuel	119.76	4,803	21,037
H <sub>2</sub> O	2.03 lb/lb fuel	106.16	4,257	18,648
Stack Emissions-#2 Oil** (140,000 Btu/gal)				
NO <sub>x</sub>	128	0.174	6.724	29.450
CO	50	0.037	1.419	6.214
CO <sub>2</sub>	3.20 lb/lb fuel	168.53	6,508	28,507
H <sub>2</sub> O	1.12 lb/lb fuel	71.20	2,750	12,044

\* 110 ppm "A" Burner, 30 ppm A-FGR Burner, 9 ppm FIR Burner  
\*\*0.02% fuel bound Nitrogen